

Plug-in units – for VME

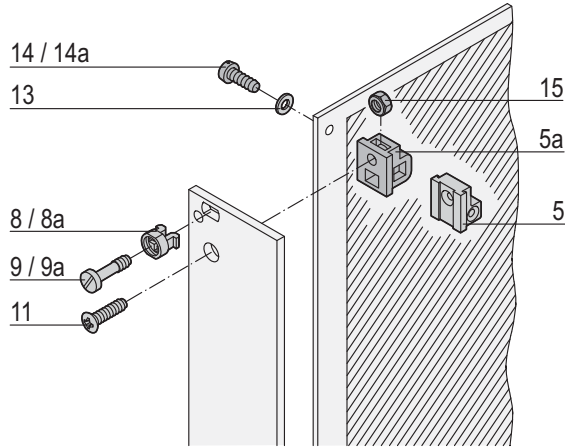









INDIVIDUAL COMPONENTS

FIXING MATERIAL FOR TRAPEZIFORM EXTRACTOR HANDLE, TYPE 1

ORDER INFORMATION



bga42545

Fixing material	Item	Image	Required Qty				Qty/PU	Part no.
			3 U		6 U			
			< 8 HP	≥ 8 HP	< 8 HP	≥ 8 HP		
Board support, die-cast zinc, with thread M2.5, for front panel and PCB fixing	5		1	2	2	4	1 piece (SPQ 10) ¹⁾	60807-181
Board support, plastic, PBT, UL 94 V-0, grey, with recess for hexagon nut M2.5, for fixing front panel	5a		1	2	2	4	1 piece (SPQ 10) ¹⁾	60807-183
Plastic sleeve, for form hole 5.9 x 3.3 PA, UL 90 V-2, grey	8		2	4	2	4	100	21100-464
Metal sleeve, for form hole 5.9 x 3.3, press-in Stainless steel	8a		2	4	-	-	100	21100-662
Pozidrive/slotted collar screw M2.5 x 11, St, nickel-plated	9		2	4	2	4	100	21100-748
Pozidrive/slotted collar screw M2.5 x 12.3, St, nickel-plated	9a		2	4	2	4	100	21101-101
Raised Pozidrive countersunk screw M2.5 x 8, St, nickel-plated	11		2	2	2	2	100	21100-429
Washer 2.7 DIN 125, St, nickel-plated, 100 pieces	13		2	2	2	2	100	21100-721
Pozidrive panhead screw M2.5 x 10, St, nickel-plated for item 5	14		2	2	2	2	100	21101-220
Panhead screw, self-tapping 2.5 x 8, St, zinc-plated for item 5b	14a		1	1	-	-	100	21100-710
Hexagon nut M2.5, nickel-plated steel for item 5b	15		1	1	-	-	100	21100-144

Plug-in units – for IEC 60297, key form 1







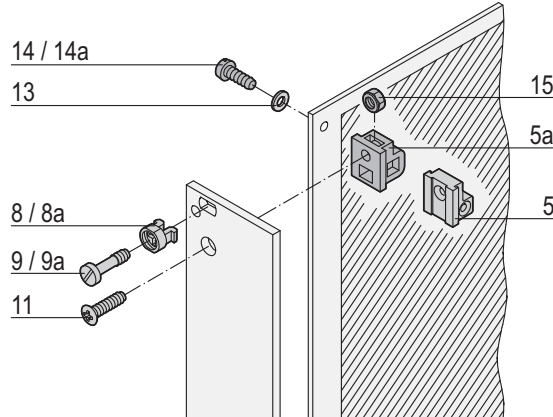



INDIVIDUAL COMPONENTS

FIXING MATERIAL FOR EXTRACTOR HANDLE IN KEY FORM 1

ORDER INFORMATION



bga42545

Fixing material	Item	Image	Required Qty		Qty/PU	Part no.
			3 U	6 U		
Board support, die-cast zinc, with thread M2.5, for front panel and PCB fixing	5		1	-	1 piece (SPQ 10) ¹⁾	60807-181
Board support, plastic, PBT, UL 94 V-0, grey, with recess for hexagon nut M2.5, for fixing front panel	5a		1	-	1 piece (SPQ 10) ¹⁾	60807-183
Plastic sleeve, for form hole 5.9 x 3.3 PA, UL 90 V-2, grey	8		1	-	100	21100-464
Metal sleeve, for form hole 5.9 x 3.3, press-in Stainless steel	8a		1	-	100	21100-662
Pozidrive/slotted collar screw M2.5 x 11, St, nickel-plated	9		2	2	100	21100-748
Pozidrive/slotted collar screw M2.5 x 12.3, St, nickel-plated	9a		2	2	100	21101-101
Raised Pozidrive countersunk screw M2.5 x 8, St, nickel-plated	11		1	-	100	21100-429
Washer 2.7 DIN 125, St, nickel-plated, 100 pieces	13		2	2	100	21100-721
Pozidrive panhead screw M2.5 x 10, St, nickel-plated for item 5	14		2	2	100	21101-220
Pan head screw, self-tapping 2.5 x 8, St, zinc-plated for item 5b	14a		1	-	100	21100-710
Hexagon nut M2.5, nickel-plated steel for item 5b	15		3	6	100	21100-144







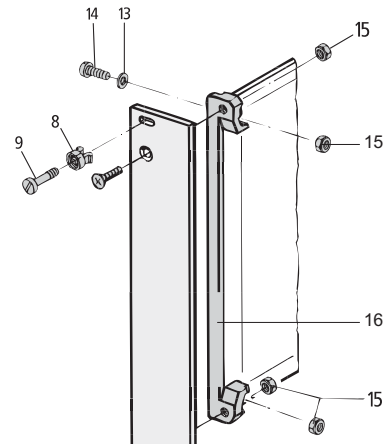
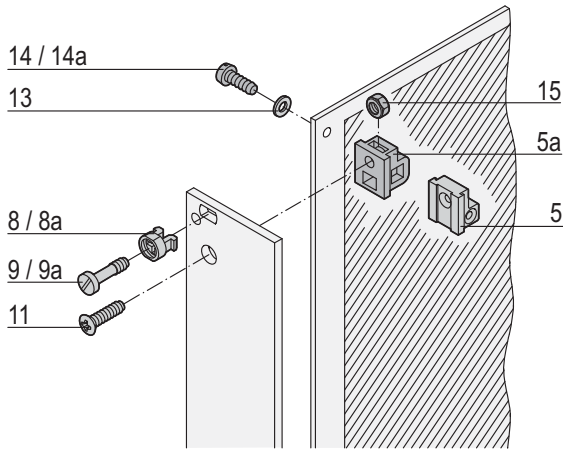





Plug-in units – for IEC 60297, key form 2

INDIVIDUAL COMPONENTS FIXING MATERIAL FOR EXTRACTOR HANDLES, KEY FORM 2

FIXING MATERIAL FOR EXTRACTOR HANDLES, KEY FORM 2



bga42545 04608137

Fixing material	Item	Image	Required Qty		Qty/PU	Part no.
			3 U	6 U		
Board support, die-cast zinc, with thread M2.5, for front panel and PCB fixing	5		1	2	1 piece (SPQ 10) ¹⁾	60807-181
Board support, plastic, PBT, UL 94 V-0, grey, with recess for hexagon nut M2.5, for fixing front panel	5a		1	2	1 piece (SPQ 10) ¹⁾	60807-183
Plastic sleeve, for form hole 5.9 x 3.3 PA, UL 90 V-2, grey	8		1	-	100	21100-464
Metal sleeve, for form hole 5.9 x 3.3, press-in Stainless steel	8a		1	-	100	21100-662
Pozidrive/slotted collar screw M2.5 x 11, St, nickel-plated	9		2	2	100	21100-748
Pozidrive/slotted collar screw M2.5 x 12.3, St, nickel-plated	9a		2	2	100	21101-101
Raised Pozidrive countersunk screw M2.5 x 8, St, nickel-plated	11		1	-	100	21100-429
Washer 2.7 DIN 125, St, nickel-plated, 100 pieces	13		2	2	100	21100-721
Pozidrive panhead screw M2.5 x 10, St, nickel-plated for item 5	14		2	2	100	21101-220
Panhead screw, self-tapping 2.5 x 8, St, zinc-plated for item 5b	14a		1	-	100	21100-710
Hexagon nut M2.5, nickel-plated steel for item 5b	15		3	-	100	21100-144
PCB bracket 4 clearance holes for front panel/PCB fixing, 4 recesses for hexagon nuts; PBT, UL 94 V-0, red	16		1	2	1 piece (SPQ 10)	60807-011

Plug-in units – for IEC 60297, trapeziform

INDIVIDUAL COMPONENTS

PCB BRACKET FOR STATIC TRAPEZIFORM HANDLE

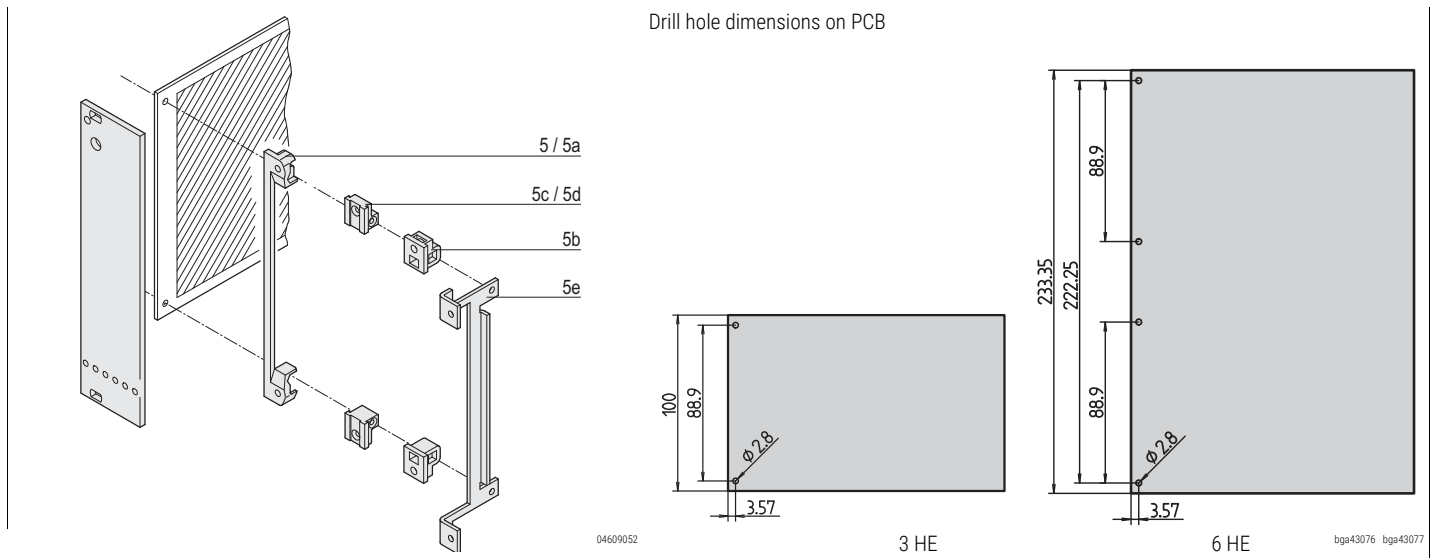

	Item	Required Qty	3 U		Qty/PU	Part no.
			3 U	6 U		
PCB bracket 4 clearance holes for front panel/PCB fixing, 4 recesses for hexagon nuts; PBT, UL 94 V-0, red	5		1	2	1 piece (SPQ 10) ¹⁾	60807-011
PCB bracket 4 threads M2.5 for front panel/PCB fixing, PBT, UL 94 V-0, grey, 1 piece	5a	 AZA45177	1	2	1 piece (SPQ 10) ¹⁾	60807-211
PCB bracket Clearance hole for front panel fixing, with recess for hexagon nut, drill hole for self-tapping screw for PCB fixing, PBT, UL 94 V-0, grey, 1 piece	5b	 AZA45177	2	4	1 piece (SPQ 10) ¹⁾	60807-183
PCB bracket 2 threads M2.5 for front panel/PCB fixing, die-cast zinc, 1 piece	5c	 06707050	2	4	1 piece (SPQ 10) ¹⁾	60807-181
PCB bracket Thread M2.5 for front panel fixing, clearance hole for PCB fixing, die-cast zinc, 1 piece	5d	 06707050	2	4	1 piece (SPQ 10) ¹⁾	60807-203
PCB bracket 4 M2.5 threads for fixing front panel/PCB for recessed PCB mounting (20 mm), mounting depth 192.24 mm, St, zinc-plated; not for europacPRO, multipacPRO, ratiopacPRO, propacPRO or compacPRO, 1 piece	5e	 AZA46586	1	2	1 piece (SPQ 10) ¹⁾	30808-871