

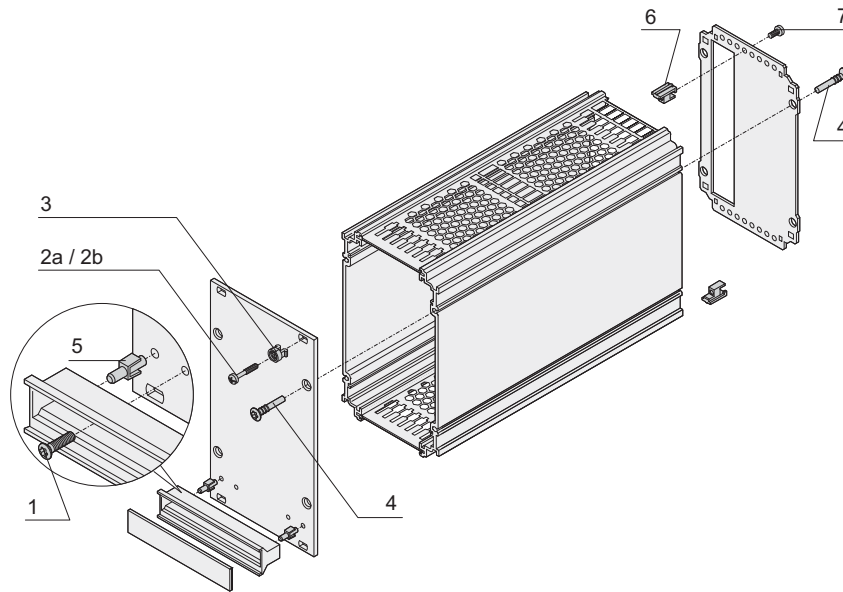













Frame type plug-in units PRO ServicePLUS

INDIVIDUAL COMPONENTS

FIXING MATERIAL (100 PIECES)



04808085

Fixing parts	Item		Required quantity per plug-in unit	Description	Qty/PU	Part no.
Fixing parts for mounting the module in subrack or case						
Torx panhead screw, M2.5 x 10, St, zinc-plated, self-forming thread	1		2	Assembly of handle on front panel	100	24560-179
Pozidrive/slotted collar screw M2.5 x 11, St, nickel-plated	2a		4 / 6*	 Mounting of front panel on horizontal rail with threaded insert pushed in to front	100	21100-748
Pozidrive/slotted collar screw M2.5 x 12.3, St, nickel-plated	2b		4 / 6*	 Front panel is fitted to horizontal rail with threaded insert pushed in to rear in the standard position	100	21101-101
Plastic sleeves for form hole 5.9 x 3.3, PA, UL 94 V-2, grey	3		4 / 6*	Is needed to fix collar screws	100	21100-464
Fixing parts for mounting the module						
Torx raised countersunk panhead screw 3 x 20, St, nickel-plated	4		8	Assembly of front panel and rear panel on extruded side panel/rear extrusion of side panel	100	24812-501
Fixing clip for trapeziform plastic handle PPE UL 94 V 0, black	5		2	Alignment aid for handle on front panel	100	21101-239
Rear panel fastener Zn die-cast	6		2	To stabilise rear panel with wide frame-type plug-in units	100	24812-402
Torx panhead screw M2.5 x 10, St, nickel-plated	7		2	To fix rear panel fastener or board fixing	100	24560-148
Board support (slot 1) Zn die-cast			2	Board support (slot 1) see page 7.78	50 pairs	24812-202
Board support (from slot 2) Zn die-cast			2	Board support (from slot 2) see page 7.78	50 pairs	24812-302
Torx panhead screw M2.5 x 6, St, nickel-plated			2	Is needed for board fixing without connector see page 7.78	100	24560-178